

SC LOWLINE



Datasheet

INDEX



Description.....	3
Tapping overview.....	4
Illustration.....	5
Dimensions.....	6
Wall mounted.....	8
Fixed feet - SF124.....	8
Options.....	10
Angled and curved radiators.....	10
Output.....	11
Accessories.....	11

DESCRIPTION

The Hudevad SC radiator is the perfect heating source for making a statement. The radiator has a high-end and timeless design that is highly customizable for the perfect fit in any environment. The radiator doesn't block the light, as its flat elements are designed for giving the room spaciousness and the impression of 'air'. The SC radiator is ideal for many applications due to its unique design that blends into the room architecture without stealing focus.

Material	Headers: Square steel tube 35 x 35 x 2.5 mm to EN 10305-5 Flat tube elements: Steel tube 70 x 11 x 1.9 mm to EN 10305-5
Test pressure	10 bar
Max. operating pressure	7.7 bar in accordance with EN 442
Max. operating temp.	95°C
Surface treatment	Pretreatment: Degreasing and passivation Priming: Primed with water based paint in pale grey Surface treatment in accordance with DIN 55900 and EN 442
Element spacing	40 and 60 mm
Length	400-3000 mm in increments of 40 and 60 mm, depending of element spacing.
Height	300 mm
Depth	SCE: 98 mm. SCD: 160 mm
Tappings	1/2" standard
Installation	Wall or floor mounted. Brackets, air vents and plugs are included.
Optional extras	Fixed feet SF124
Colour	Powder coated in white RAL 9016. Gloss 70 Option: Painted in other standard RAL colours. For more information, please see the Hudevad Colour brochure at www.hudevad.com

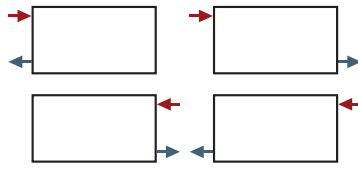
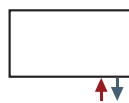
TAPPING OVERVIEW

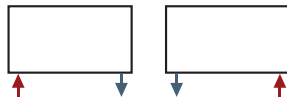
Tapping code	Tapping type	Tapping possibilities
10	ABCD (4 tap)	
11	FF (6 tap)	
12	EE (6 tap)	
15	E/F No valve	

TAPPING CODE 10 - ABCD - Side tapplings

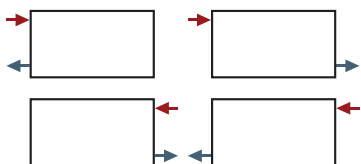

View from the front

Drawing 4.1

SCE,
profile

SCD,
profile

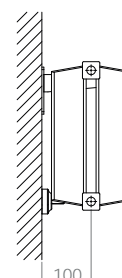
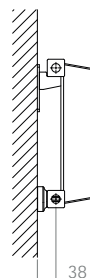
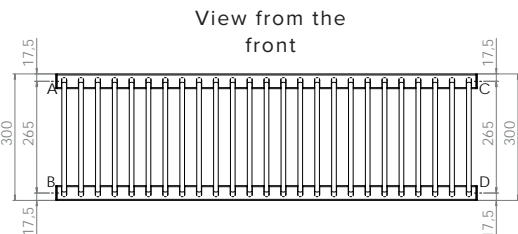

Centre distance N is calculated as: Radiator height (H)-35 mm

B-D tapping combination:

To ensure optimum water flow, bottom headers are factory fitted with a diverter plate. Therefore, flow and return must be stated when ordering.

Note: For lengths greater than 1800 mm, the flow and return must always be indicated when ordering

TAPPING CODE 11, 12 AND 15 - EE / FF and E/F - Underside tapings

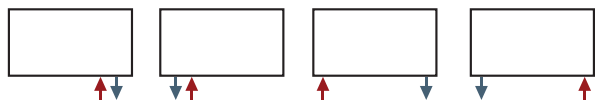

View from the front

Drawing 5.1

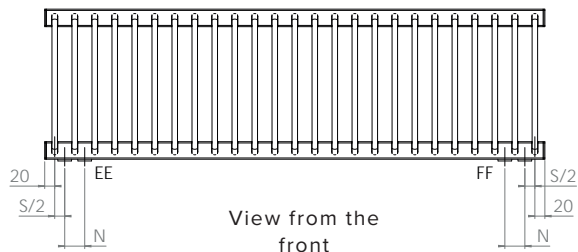

View from the front

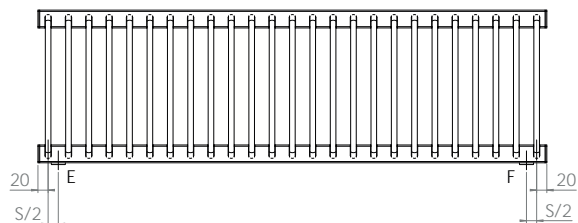
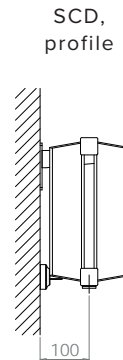
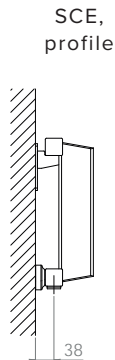

Centre distance N at tapping EE/FF corresponds to element spacing S
 Center distance N at tapping EF/FE is calculated: Radiator length L - element spacing - 40 mm

Note:
 Flow is always placed in the outer tapping. Radiator is factory fitted with a diverter plate between tapings to ensure optimum water flow.

ILLUSTRATION

Drawing 5.2

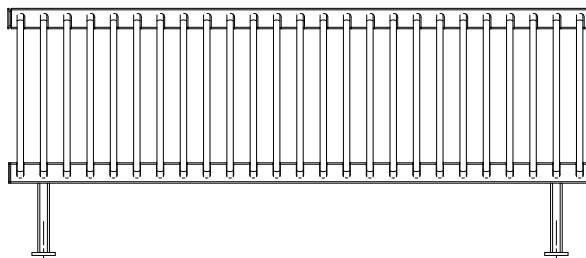

DIMENSIONS

Radiator length is calculated as:
 Element spacing $S \times (\text{no. of elements} - 1) + 40 \text{ mm}$

No. of elements for a given radiator length is calculated as:
 $(\text{radiator length } L - 40) / \text{element spacing } S + 1$

Length table: see page 7

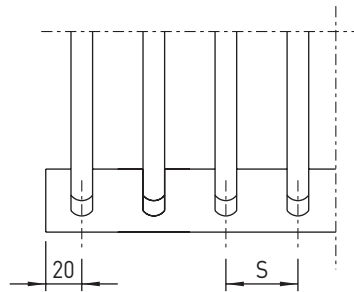

Element spacing $S = 40 \text{ or } 60 \text{ mm}$

Drawing 6.1

LENGTH AND ELEMENT SPACING TABLE

Length mm	Element spacing, mm		Length mm	Element spacing, mm	
	40	60		40	60
400	10	7	1780		30
440	11		1800	45	
460		8	1840	46	31
480	12		1880	47	
520	13	9	1900		32
560	14		1920	48	
580		10	1960	49	33
600	15		2000	50	
640	16	11	2020		34
680	17		2040	51	
700		12	2080	52	35
720	18		2120	53	
760	19	13	2140		36
800	20		2160	54	
820		14	2200	55	37
840	21		2240	56	
880	22	15	2260		38
920	23		2280	57	
940		16	2320	58	39
960	24		2360	59	
1000	25	17	2380		40
1040	26		2400	60	
1060		18	2440	61	41
1080	27		2480	62	
1120	28	19	2500		42
1160	29		2520	63	
1180		20	2560	64	43
1200	30		2600	65	
1240	31	21	2620		44
1280	32		2640	66	
1300		22	2680	67	45
1320	33		2720	68	
1360	34	23	2740		46
1400	35		2760	69	
1420		24	2680	67	45
1440	36		2720	68	
1480	37	25	2740		46
1520	38		2760	69	
1540		26	2800	70	47
1560	39		2840	71	
1600	40	27	2860		48
1640	41		2880	72	
1660		28	2920	73	49
1680	42		2960	74	
1720	43	29	2980		50
1760	44		3000	75	

SC WALL MOUNTED

Drawing 8.1

SC single (SCE), profile

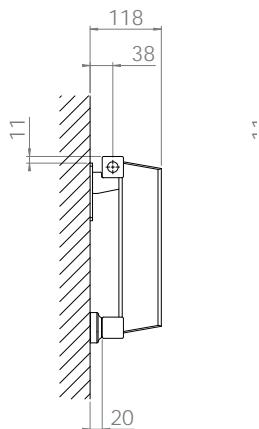

SC double (SCD), profile

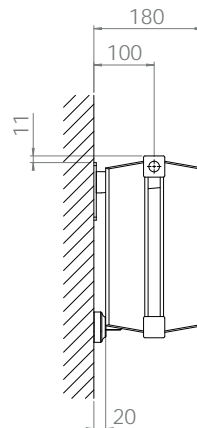

No. of brackets and spacers	Element spacing			
	40 mm		60 mm	
	Elements	L, mm	Elements	L, mm
2/2	10-25	400-1000	7-17	400-1000
3/2	26-50	1040-2000	18-33	1060-1960
4/3	51-75	2040-3000	34-50	2020-2980

SC FLOOR MOUNTED - FIXED FEET SF124

Drawing 8.2

SF124 feet, profile

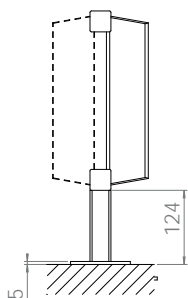

Foot plate for SF124 feet, top view

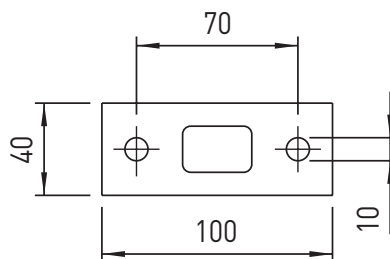

- Application** For use where wall mounting is not possible, e.g. in front of glazing
- Construction** 20 x 30 x 2 mm steel tube with foot plate of 5 mm steel
Feet are welded onto the radiator
- Height** 124 mm from upper floor surface to lower edge of radiator
- Colour** Same as radiator

VIEW FROM THE FRONT

Drawing 9.1

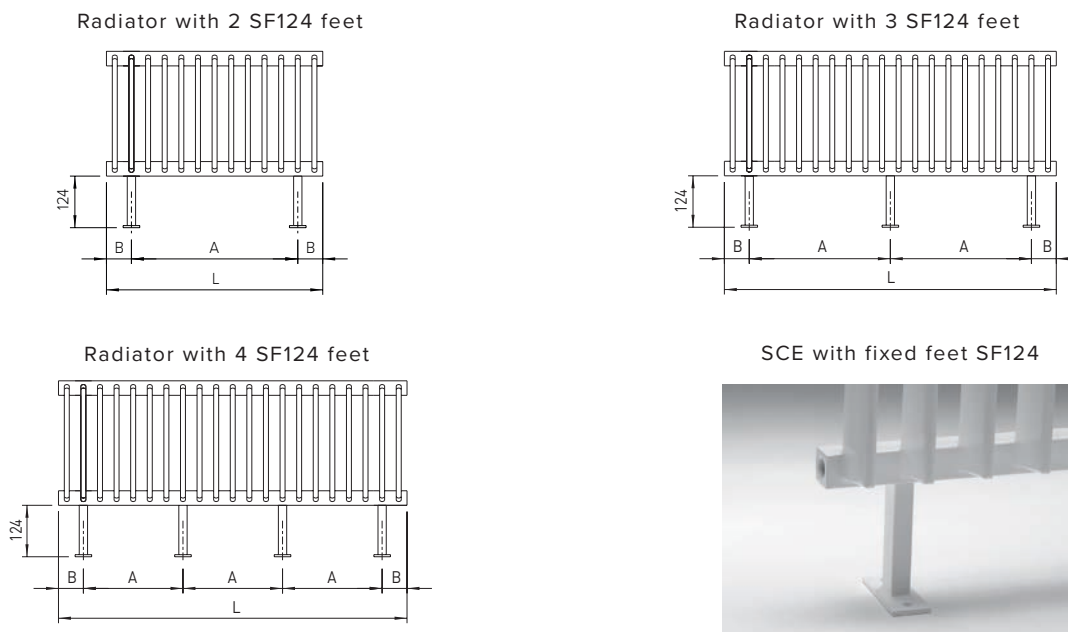

Distance B at different tapping combinations

Element spacing, mm	Tapping combinations	
	ABCD	EE/FF and E/F
40	60	140
60	80	200

POSITION AND NO. OF FEET

No. of feet	Element spacing				
	A, mm	40 mm		60 mm	
		Elements	L, mm	Elements	L, mm
2	L - 2B	10-40	400-1600	7-27	400-1600
3	(L - 2B)/2	41-70	1640-2800	28-47	1660-2800
4	(L - 2B)/3	71-75	2840-3000	48-50	2860-2980

Feet will be welded under an element or between 2 elements. Therefore, distance A may vary. Distance B depends on tapping combination, see table above.

OPTIONS

ANGLED AND CURVED RADIATORS

Description All SCE and SCD radiators can be supplied angled or curved. Tapping designations etc. follow the same principles as for straight radiators.

Output calculation, angled: The exact no. of elements is determined by Hudevad taking ordered angle and element spacing into consideration.

Output calculation, curved: When calculating the radiator output the length of the horizontal header and not the length of the wall is to be used.

Installation Wall or floor mounted.
 Note: Unless otherwise specified, the radiator is supplied with bracket SB20 (SCE) or SB82 (SCD).

If alternative wall distance is required, please consult Hudevad.

INTERNAL ANGLES

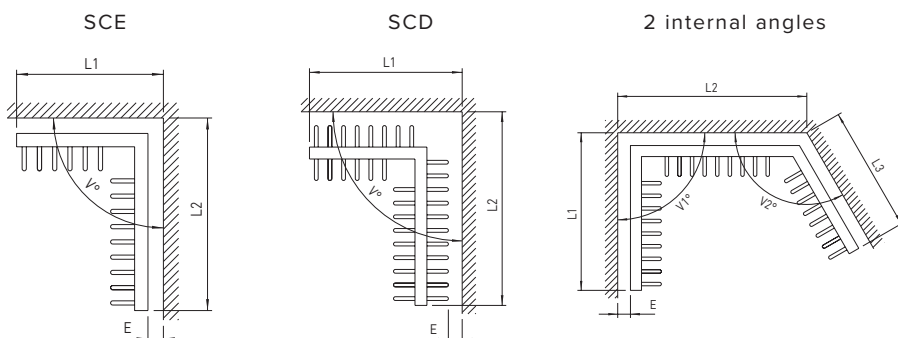

EXTERNAL ANGLE

Drawing 10.1

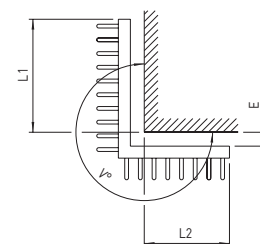

INTERNAL CURVE

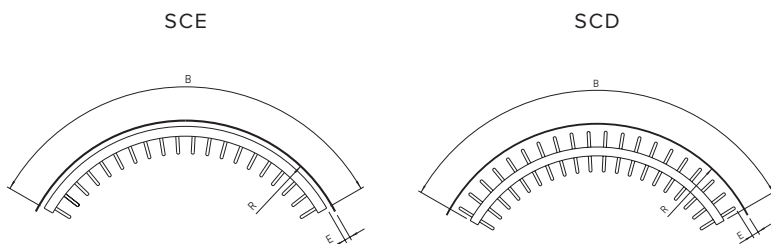

EXTERNAL CURVE

Drawing 10.2

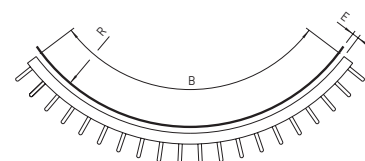

OUTPUT

SC SINGLE (SCE)

Height, mm	W/m, 75°/65°/20°		W/m, 70°/40°/20°		W/m, 60°/30°/20°		Water content litres/ element	Weight kg/ element
	Element spacing, mm		Element spacing, mm		Element spacing, mm			
300	40	60	40	60	40	60	0.25	0.9
	595	469	345	272	201	159		

SC DOUBLE (SCD)

Height, mm	W/m, 75°/65°/20°		W/m, 70°/40°/20°		W/m, 60°/30°/20°		Water content liter/ element	Weight kg/ element
	Element spacing, mm		Element spacing, mm		Element spacing, mm			
300	40	60	40	60	40	60	0.37	1.5
	960	729	556	422	325	247		

ACCESSORIES

Drawing 11.1

Bracket SB20

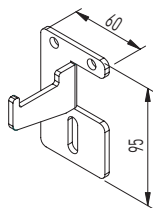

Bracket, profile

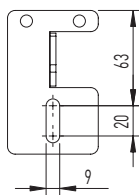

Spacer



SCE uses bracket SB20 and SCD uses bracket SB82

Note: Bracket SB82 has same backplate with longer outreach