

- Leveransvillkor: AA VVS 2009
- Skyddsemballerad i plast och tre lager wellpapp.

Oxford

---





## Anslutning



### Tillgängliga storlekar:

#### Väggmontage

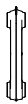

410 x 80  
1 Sektioner

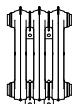

410 x 278  
3 Sektioner

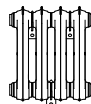

410 x 360  
4 Sektioner

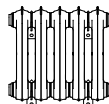

410 x 442  
5 Sektioner

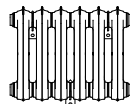

410 x 524  
6 Sektioner

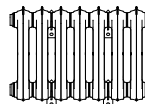

410 x 606  
7 Sektioner

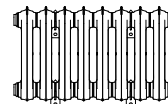

410 x 688  
8 Sektioner

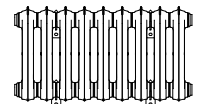

410 x 770  
9 Sektioner

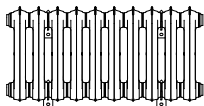

410 x 852  
10 Sektioner

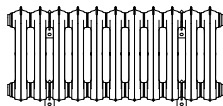

410 x 934  
11 Sektioner

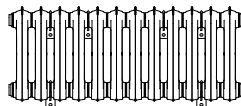

410 x 1016  
12 Sektioner

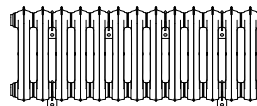

410 x 1098  
13 Sektioner

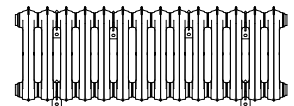

410 x 1180  
14 Sektioner

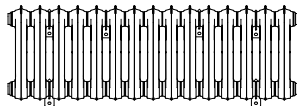

410 x 1262  
15 Sektioner

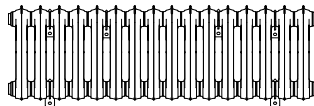

410 x 1344  
16 Sektioner

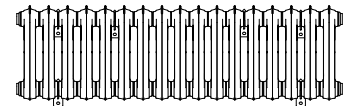

410 x 1426  
17 Sektioner



660 x 80  
1 Sektioner

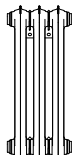

660 x 278  
3 Sektioner

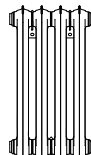

660 x 360  
4 Sektioner

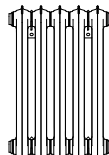

660 x 442  
5 Sektioner

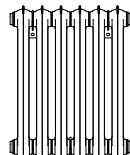

660 x 524  
6 Sektioner

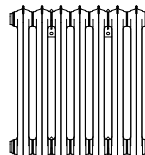

660 x 606  
7 Sektioner

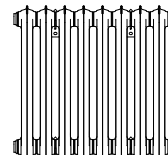

660 x 688  
8 Sektioner

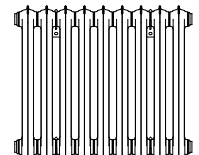

660 x 770  
9 Sektioner

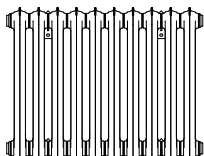

660 x 852  
10 Sektioner

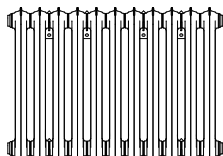

660 x 934  
11 Sektioner

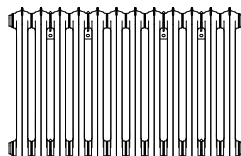

660 x 1016  
12 Sektioner

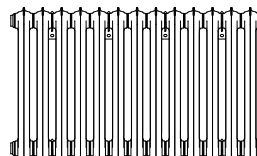

660 x 1098  
13 Sektioner

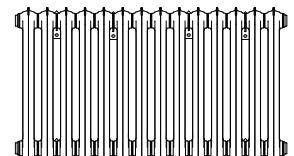

660 x 1180  
14 Sektioner

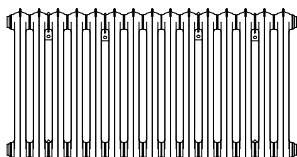

660 x 1262  
15 Sektioner

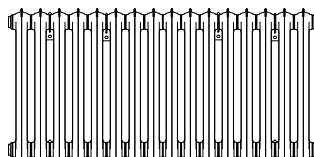

660 x 1344  
16 Sektioner

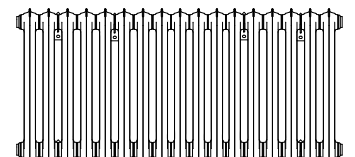



660 x 1426  
17 Sektioner

# Oxford

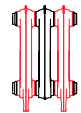

## Golvstående

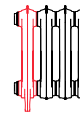
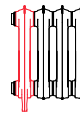
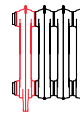
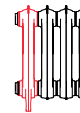
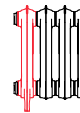
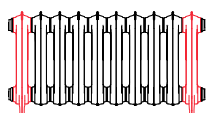
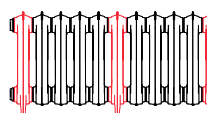
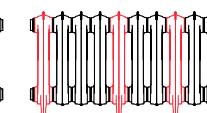
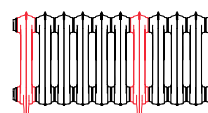
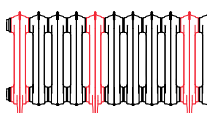
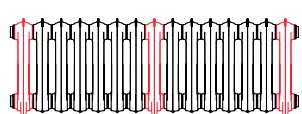
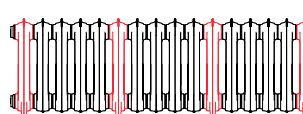
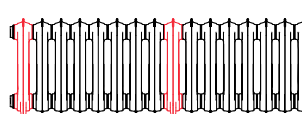
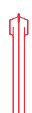
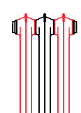
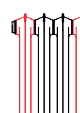
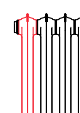
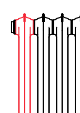
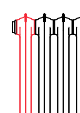
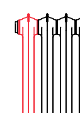
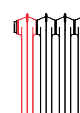
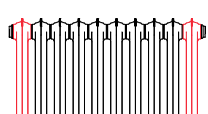
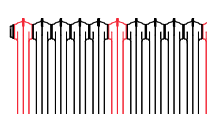
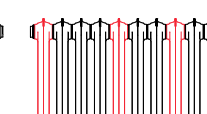
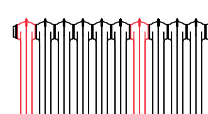
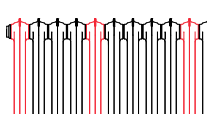
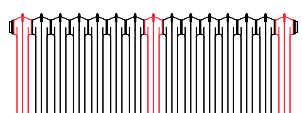
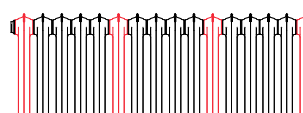
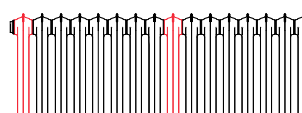
 470 x 80 1 Sektioner (1)	 470 x 278 3 Sektioner (2+1)	 470 x 360 4 Sektioner (2+2)	 470 x 442 5 Sektioner (2+3)	 470 x 524 6 Sektioner (2+4)	 470 x 606 7 Sektioner (2+5)	 470 x 688 8 Sektioner (2+6)	 470 x 770 9 Sektioner (2+7)
 470 x 852 10 Sektioner (2+8)	 470 x 934 11 Sektioner (3+8)	 470 x 1016 12 Sektioner (4+8)	 470 x 1098 13 Sektioner (3+10)	 470 x 1180 14 Sektioner (4+10)			
 470 x 1262 15 Sektioner (3+12)	 470 x 1344 16 Sektioner (4+12)	 470 x 1426 17 Sektioner (3+14)					
 710 x 80 1 Sektioner (1)	 710 x 278 3 Sektioner (2+1)	 710 x 360 4 Sektioner (2+2)	 710 x 442 5 Sektioner (2+3)	 710 x 524 6 Sektioner (2+4)	 710 x 606 7 Sektioner (2+5)	 710 x 688 8 Sektioner (2+6)	 710 x 770 9 Sektioner (2+7)
 710 x 852 10 Sektioner (2+8)	 710 x 934 11 Sektioner (3+8)	 710 x 1016 12 Sektioner (4+8)	 710 x 1098 13 Sektioner (3+10)	 710 x 1180 14 Sektioner (4+10)			
 710 x 1262 15 Sektioner (3+12)	 710 x 1344 16 Sektioner (4+12)	 710 x 1426 17 Sektioner (3+14)					

## Teknisk data

Drifttryck: 1000 kPa Maximal drifttemperatur 95°C

A ↓ [mm]	B ↔ [mm]	C [mm]	75/65/20°C [W]	55/45/20°C [W]	D [mm]	D1 [mm]	D2 [mm]	H [dm³]	 [kg]
Väggmontage									
410	80	297	86	44	—	—	—	1,65	8,10
410	278	297	257	133	82	98	—	4,95	24,70
410	360	297	343	177	—	98	—	6,60	33,00
410	442	297	429	222	246	98	—	8,25	41,30
410	524	297	515	266	—	98	—	9,90	49,60
410	606	297	601	310	246	180	—	11,55	57,90
410	688	297	686	355	—	180	—	13,20	66,20
410	770	297	772	399	410	180	—	14,85	74,50
410	852	297	858	443	492	180	—	16,50	82,80
410	934	297	944	488	574	180	—	18,15	91,10
410	1016	297	1030	532	656	180	164	19,80	99,40
410	1098	297	1115	577	738	180	164	21,45	107,70
410	1180	297	1201	621	820	180	246	23,10	116,00
410	1262	297	1287	665	902	180	246	24,75	124,30
410	1344	297	1373	710	984	180	246	26,40	132,60
410	1426	297	1459	754	1066	180	246	28,05	140,90
660	80	555	143	76	—	—	—	2,25	14,70
660	278	555	429	227	82	98	—	6,75	44,50
660	360	555	572	303	—	98	—	9,00	59,40
660	442	555	715	379	246	98	—	11,25	74,30
660	524	555	858	454	—	98	—	13,50	89,20
660	606	555	1001	530	246	180	—	15,75	104,10
660	688	555	1144	606	328	180	—	18,00	119,00
660	770	555	1287	682	410	180	—	20,25	133,90
660	852	555	1430	757	492	180	—	22,50	148,80
660	934	555	1573	833	574	180	164	24,75	163,70
660	1016	555	1716	909	656	180	164	27,00	178,60
660	1098	555	1859	985	738	180	246	29,25	193,50
660	1180	555	2002	1060	820	180	246	31,50	208,40
660	1262	555	2145	1136	902	180	246	33,75	223,30
660	1344	555	2288	1212	984	180	246	36,00	238,20
660	1426	555	2431	1288	1066	180	246	38,25	253,10

Radiatorer med 13 sektioner eller fler levereras i två eller fler enheter

# Oxford

A ↓ [mm]	B ↔ [mm]	C [mm]	75/65/20°C [W]	55/45/20°C [W]	D [mm]	D1 [mm]	D2 [mm]	H [dm <sup>3</sup> ]	W [kg]
<b>Golvstående</b>									
470	80	297	86	44	–	–	–	1,65	8,7
470	278	297	257	133	–	–	–	4,95	25,9
470	360	297	343	177	–	–	–	6,60	34,0
470	442	297	429	222	–	–	–	8,25	42,1
470	524	297	515	266	–	–	–	9,90	50,2
470	606	297	601	310	–	–	–	11,55	58,3
470	688	297	686	355	–	–	–	13,20	66,4
470	770	297	772	399	–	–	–	14,85	74,5
470	852	297	858	443	–	–	–	16,50	82,6
470	934	297	944	488	–	–	–	18,15	90,7
470	1016	297	1030	532	–	–	–	19,80	98,8
470	1098	297	1115	577	–	–	–	21,45	107,5
470	1180	297	1201	621	–	–	–	23,10	116,2
470	1262	297	1287	665	–	–	–	24,75	115,6
470	1344	297	1373	710	–	–	–	26,40	132,4
470	1426	297	1459	754	–	–	–	28,05	139,9
710	80	555	143	76	–	–	–	2,25	15,3
710	278	555	429	227	–	–	–	6,75	45,7
710	360	555	572	303	–	–	–	9,00	60,4
710	442	555	715	379	–	–	–	11,25	75,1
710	524	555	858	454	–	–	–	13,50	89,8
710	606	555	1001	530	–	–	–	15,75	104,5
710	688	555	1144	606	–	–	–	18,00	119,2
710	770	555	1287	682	–	–	–	20,25	133,9
710	852	555	1430	757	–	–	–	22,50	148,6
710	934	555	1573	833	–	–	–	24,75	163,3
710	1016	555	1716	909	–	–	–	27,00	178,0
710	1098	555	1859	985	–	–	–	29,25	193,3
710	1180	555	2002	1060	–	–	–	31,50	208,6
710	1262	555	2145	1136	–	–	–	33,75	208,0
710	1344	555	2288	1212	–	–	–	36,00	238,0
710	1426	555	2431	1288	–	–	–	38,25	252,1

Radiatorer med 13 sektioner eller fler levereras i två eller fler enheter

Väggmontage

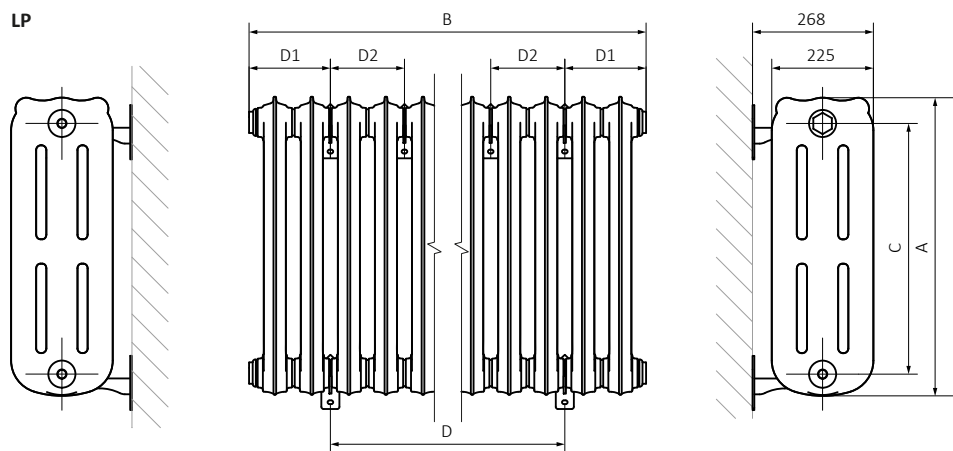
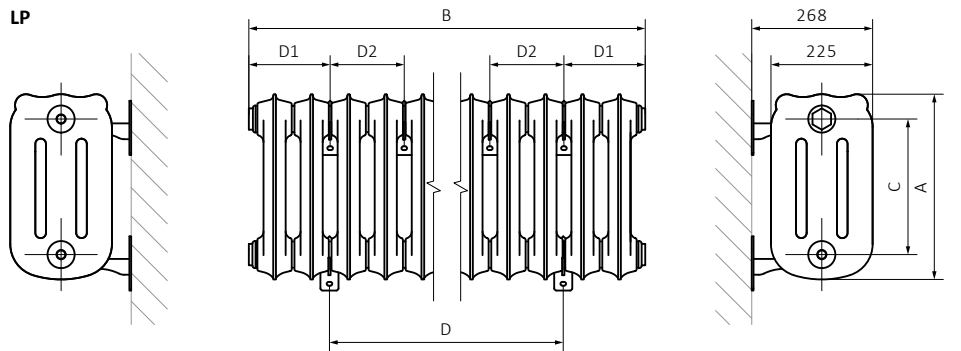

A – Höjd B – Djup C – Mått mellan anslutningarna D – Horisontellt avstånd mellan konsoler

# Oxford

Golvstående

